

INSTRUCTION MANUAL

DEWALT[®]

XR LI-ION

DCT416-XE

10.8 V CORDLESS IMAGING THERMOMETER



Definitions: Safety Guidelines

The definitions below describe the level of severity for each signal word. Please read the manual and pay attention to these symbols.

⚠DANGER: Indicates an imminently hazardous situation which, if not avoided, **will** result in **death or serious injury**.

⚠WARNING: Indicates a potentially hazardous situation which, if not avoided, **could** result in **death or serious injury**.

⚠CAUTION: Indicates a potentially hazardous situation which, if not avoided, **may** result in **minor or moderate injury**.

NOTICE: indicates a practice **not related to personal injury** which, if not avoided, **may** result in **property damage**.

IF YOU HAVE ANY QUESTIONS OR COMMENTS ABOUT THIS OR ANY DeWALT TOOL, CALL US AT: 1800 444 224 (Aust) or 0800 339 258 (NZ).

Technical Data

		DCT416-XE
Voltage	VDC	10.8
Battery type		Li-Ion
Screen size	mm	55.9
		Color TFT LCD with Backlight
Weight (without battery pack)	kg	0.5
Run-Time		Approx. 10 hours
Temperature Range (Operating)		-5 °C to 45 °C (23 °F to 113 °F)
Temperature Range (Storage)		-20 °C to 60 °C (-4 °F to 140 °F)
Temperature Measurement Range		-10 °C to 250 °C (14 °F to 480 °F)
Relative Humidity		10 to 90%, non-condensing
Spectral Response		8µm to 12µm

Field of View	20° x 20°
IFOV (Instantaneous Field of View)	25 mm at 1 m (1" at 39.3")
Accuracy	Below 100 °C (212 °F) +/- 2 °C (+/- 3.6 °F) Above 100 °C (212 °F) +/- 2% of reading. Ambient temperature for stated accuracy 23 °C (73.4 °F).
Emissivity	0.1 to 1.0, adjustable in 0.01 increments
Temperature scales	°C or °F

⚠ WARNING: This is a Class A product. In a domestic environment this product may cause radio interference in which case the user may be required to take adequate measures.

⚠ WARNING: Increased electrostatic voltage may cause display to fail and all unsaved data will be lost. If the screen freezes, remove the 10.8 V battery pack to reset the unit. Reinsert the battery pack and press the power on button.

SAFETY INSTRUCTIONS FOR POWER TOOLS

When using power tools, always observe the safety regulations applicable in your country to reduce the risk of fire, electric shock and personal injury. Read the following safety instructions before attempting to operate this product. Keep these instructions in a safe place.



WARNING: To reduce the risk of injury, user must read the instruction manual.

GENERAL POWER TOOL SAFETY WARNINGS



WARNING! Read all safety warnings and all instructions Failure to follow the warnings and instructions may result in electric shock, fire and/or serious injury.

The term "power tool" in the warnings refers to your mains-operated (corded) power tool or battery-operated (cordless) power tool.

**SAVE ALL WARNINGS AND INSTRUCTIONS
FOR FUTURE REFERENCE**

1) WORK AREA SAFETY

- a) **Keep work area clean and well lit.** Cluttered or dark areas invite accidents.
- b) **Keep children and bystanders away while operating an imaging thermometer.** Distractions can cause you to lose control.

2) PERSONAL SAFETY

- a) **Stay alert, watch what you are doing and use common sense when operating an imaging thermometer. Do not use an imaging thermometer while you are tired or under the influence of drugs, alcohol or medication.** A moment of inattention while operating the imaging thermometer may result in serious personal injury.
- b) **Do not overreach. Keep proper footing and balance at all times.** This enables better control of the imaging thermometer in unexpected situations.

3) USE AND CARE

- a) **Store an idle imaging thermometer out of the reach of children and do not allow persons unfamiliar with the imaging thermometer or these instructions to operate the imaging thermometer.** The imaging thermometer may be dangerous in the hands of untrained users.
- b) **Use the imaging thermometer, accessories, etc. in accordance with these instructions, taking into account the working conditions and the work to be performed.** Use of the imaging thermometer for operations different from those intended could result in a hazardous situation.

4) BATTERY TOOL USE AND CARE

- a) **Recharge only with the charger specified by DEWALT.** A charger that is suitable for one type of battery pack may create a risk of fire when used with another battery pack.
- b) **When battery pack is not in use, keep it away from other metal objects like paper clips, coins, keys, nails, screws, or other small metal objects that can make a connection from one terminal to another.** Shorting the battery terminals together may cause burns or a fire.
- c) **Under abusive conditions, liquid may be ejected from the battery; avoid contact. If contact accidentally occurs, flush with water. If liquid contacts eyes, additionally seek medical help.** Liquid ejected from the battery may cause irritation or burns.

Electrical Safety

The electric motor has been designed for one voltage range only. Always check that the power supply corresponds to the voltage on the rating plate. 220–240 V AC means your tool will operate on alternating current. Operation at a voltage outside this range can cause loss of power and can result in overheating. All DEWALT tools are factory tested; if this tool does not operate, check the power supply. Your DEWALT tool is double insulated, therefore no earth wire is required.

- **Young children and the infirm.** This appliance is not intended for use by young children or infirm persons without supervision. Young children should be supervised to ensure that they do not play with this appliance.
- **Replacement of the supply cord.** If the supply cord or plug is damaged, it must be replaced by the manufacturer or an authorised DEWALT Service Centre in order to avoid a hazard.

Extension Cords

⚠ CAUTION: Use only extension cords that are approved by the country's Electrical Authority. Before using extension cords, inspect them for loose or exposed wires, damaged insulation and defective fittings. Replace the cord if necessary.

SAFETY INFORMATION FOR IMAGING THERMOMETERS

⚠ WARNING:

- **Do not disassemble or modify the imaging thermometer. Have the imaging thermometer serviced by a qualified repair person using only identical replacement parts.** This will ensure that the safety of the power tool is maintained. If you need assistance contact DEWALT at 1800 444 224 (Aust) or 0800 339 258 (NZ), or go to www.dewalt.com.au or www.dewalt.co.nz on the Internet.
- **Do not operate the imaging thermometer in explosive atmospheres, such as in the presence of flammable liquids, gases, or dust.** Imaging thermometers create sparks which may ignite the dust or fumes.
- **The imaging thermometer should only be used with specifically designated DEWALT batteries.** Use of any other batteries may create a risk of fire.
- **Store the imaging thermometer out of reach of children and other untrained persons.** Tools are dangerous in the hands of untrained users.
- **Do not remove or deface warning labels.**

- Do not use imaging thermometer for testing temperatures of cooked or uncooked food.
- Do not touch surfaces to confirm hot temperature readings.
- Do not use for taking human or animal body temperatures.

⚠ WARNING: Burn hazard. The reading may not be accurate if the imaging thermometer is in the presence of strong electromagnetic fields (such as arc welders, induction heaters, radio transmitters, etc.). Do not use the imaging thermometer under these conditions.

⚠ WARNING: The imaging thermometer measures surface temperature only. Objects behind the surface may have significantly different temperatures, posing a burn or frostbite hazard.

⚠ WARNING: See emissivity information for actual temperatures. Reflective objects result in lower than actual temperature measurements and can pose a burn hazard.

⚠ WARNING: Do not expose imaging thermometer to excessive heat such as sunshine, fire or the like.

⚠ CAUTION: When not in use, place imaging thermometer on its side on a stable surface where it will not cause a tripping or falling hazard. Some tools with large battery packs will stand upright on the battery pack but may be easily knocked over.

NOTICE: Modifications not authorized by the manufacturer may void user's authority to operate this device.

NOTICE: To avoid damage to the imaging thermometer, do not leave it exposed to high temperature environments or heat sources, for example, in a vehicle in the sun. Always operate the imaging thermometer within the operating range noted in the specification chart.

NOTICE: Do not point the imaging thermometer (with or without the lens cover engaged) at the sun or other intensive energy sources that emit laser radiation. This can damage the detector inside the imaging thermometer and can effect the accuracy.

MICRO SD MEMORY CARD

⚠ WARNING: Choking hazard. The micro SD memory card is a small part that could lead to a choking hazard and is not intended for children.

NOTICE: It is recommended to use the micro SD memory card supplied with the imaging thermometer. DeWALT does not warrant the use or reliability of other after-market cards with different brands or capacities. It is also recommended to frequently transfer the saved images to a computer as a backup.

Important Safety Instructions for All Battery Packs

When ordering replacement battery packs, be sure to include catalog number and voltage. Consult the chart at the end of this manual for compatibility of chargers and battery packs.

The battery pack is not fully charged out of the carton. Before using the battery pack and charger, read the safety instructions below. Then follow charging procedures outlined.

SAVE ALL WARNINGS AND INSTRUCTIONS FOR FUTURE REFERENCE

- Do not charge or use battery in explosive atmospheres, such as in the presence of flammable liquids, gases or dust. Inserting or removing the battery from the charger may ignite the dust or fumes.
- Never force battery pack into charger. Do not modify battery pack in any way to fit into a non-compatible charger as battery pack may rupture causing serious personal injury. Consult the chart at the end of this manual for compatibility of batteries and chargers.
- Charge the battery packs only in DeWALT chargers.
- DO NOT splash or immerse in water or other liquids.
- Do not store or use the tool and battery pack in locations where the temperature may reach or exceed 40 °C (105 °F) (such as outside sheds or metal buildings in summer).

⚠ WARNING: Fire hazard. Never attempt to open the battery pack for any reason. If battery pack case is cracked or damaged, do not insert into charger. Do not crush, drop or damage battery pack. Do not use a battery pack or charger that has received a sharp blow, been dropped, run over or damaged in any way (i.e., pierced with a nail, hit with a hammer, stepped on). Damaged battery packs should be returned to service center for recycling.

⚠ WARNING: Fire hazard. Do not store or carry battery so that metal objects can contact exposed battery terminals. For example, do not place battery in aprons, pockets, tool boxes, product kit boxes, drawers, etc., with loose nails, screws, keys, etc. Transporting batteries can possibly cause fires if the battery terminals inadvertently come in contact with conductive materials such as keys, coins, hand tools and the like. The US Department of Transportation Hazardous Material

Regulations (HMR) actually prohibits transporting batteries in commerce or on airplanes (i.e., packed in suitcases and carry-on luggage) UNLESS they are properly protected from short circuits. So when transporting individual batteries, make sure that the battery terminals are protected and well insulated from materials that could contact them and cause a short circuit.

SPECIFIC SAFETY INSTRUCTIONS FOR LITHIUM ION (Li-Ion)

- **Do not incinerate the battery pack even if it is severely damaged or is completely worn out.** The battery pack can explode in a fire. Toxic fumes and materials are created when lithium ion battery packs are burned.
- **If battery contents come into contact with the skin, immediately wash area with mild soap and water.** If battery liquid gets into the eye, rinse water over the open eye for 15 minutes or until irritation ceases. If medical attention is needed, the battery electrolyte is composed of a mixture of liquid organic carbonates and lithium salts.
- **Contents of opened battery cells may cause respiratory irritation.** Provide fresh air. If symptoms persists, seek medical attention.

⚠ WARNING: Burn hazard. Battery liquid may be flammable if exposed to spark or flame.

Important Safety Instructions for All Battery Chargers

SAVE THESE INSTRUCTIONS: This manual contains important safety and operating instructions for battery chargers.

- Before using charger, read all instructions and cautionary markings on charger, battery pack, and product using battery pack.

⚠ WARNING: Shock hazard. Do not allow any liquid to get inside charger. Electric shock may result.

⚠ CAUTION: Burn hazard. To reduce the risk of injury, charge only DeWALT rechargeable batteries. Other types of batteries may burst causing personal injury and damage.

NOTICE: Under certain conditions, with the charger plugged in to the power supply, the charger can be shorted by foreign material. Foreign materials of a conductive nature such as, but not limited to, grinding dust, metal chips, steel wool, aluminum foil, or any buildup of metallic particles should be kept away from charger cavities. Always unplug the charger from the power supply when there is no battery pack in the cavity. Unplug charger before attempting to clean.

- **DO NOT attempt to charge the battery pack with any chargers other than the ones in this manual.** The charger and battery pack are specifically designed to work together.
- **These chargers are not intended for any uses other than charging DeWALT rechargeable batteries.** Any other uses may result in risk of fire, electric shock or electrocution.
- **Do not expose charger to rain or snow.**
- **Pull by plug rather than cord when disconnecting charger.** This will reduce risk of damage to electric plug and cord.
- **Make sure that cord is located so that it will not be stepped on, tripped over, or otherwise subjected to damage or stress.**
- **Do not use an extension cord unless it is absolutely necessary.** Use of improper extension cord could result in risk of fire, electric shock, or electrocution.
- **When operating a power tool outdoors, use an extension cord suitable for outdoor use.** Use of a cord suitable for outdoor use reduces the risk of electric shock.
- **Do not place any object on top of charger or place the charger on a soft surface that might block the ventilation slots and result in excessive internal heat.** Place the charger in a position away from any heat source. The charger is ventilated through slots in the top and the bottom of the housing.
- **Do not operate charger with damaged cord or plug.**
- Do not operate charger if it has received a sharp blow, been dropped, or otherwise damaged in any way. Take it to an authorized service center.
- **Do not disassemble charger; take it to an authorized service center when service or repair is required.** Incorrect reassembly may result in a risk of electric shock, electrocution or fire.
- **Disconnect the charger from the outlet before attempting any cleaning. This will reduce the risk of electric shock.** Removing the battery pack will not reduce this risk.
- **NEVER** attempt to connect 2 chargers together.
- **The charger is designed to operate on standard 230 V household electrical power. Do not attempt to use it on any other voltage.** This does not apply to the vehicular charger.

Chargers

Your tool uses a DeWALT charger. Be sure to read all safety instructions before using your charger. Consult the chart on the back cover of this manual for compatibility of chargers and battery packs.

Charging Procedure (Fig. 1)

1. Plug the charger into an appropriate outlet before inserting battery pack.
2. Insert the battery pack (A) into the charger, as shown in Figure 1, making sure the pack is fully seated in charger. The red (charging) light will blink continuously indicating that the charging process has started.
3. The completion of charge will be indicated by the red light remaining ON continuously. The pack is fully charged and may be used at this time or left in the charger.

FIG. 1

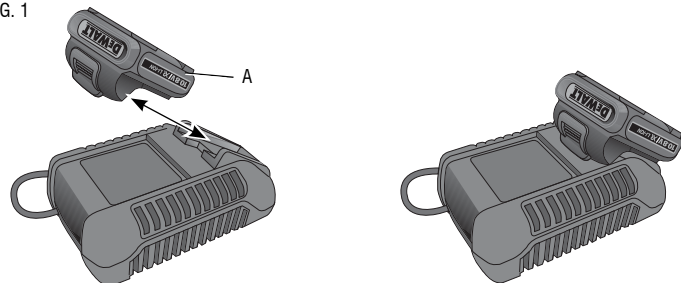

Indicator Light Operation

PACK CHARGING.....	— — — — —
PACK CHARGED.....	■ ■ ■ ■ ■
HOT/COLD PACK DELAY.....	— ■ — ■ — ■ — ■ — ■
REPLACE PACK.....	● ● ● ● ● ● ● ● ● ● ● ● ● ● ● ●

Charge Indicators

Some chargers are designed to detect certain problems that can arise with battery packs. Problems are indicated by the red light flashing at a fast rate. If this occurs, re-insert battery pack into the charger. If the problem persists, try a different battery pack to determine if the charger is OK. If the new pack charges correctly, then the original pack is defective and should be returned to a service center or other collection site for recycling. If the new battery pack elicits the same trouble indication as the original, have the charger tested at an authorized service center.

HOT/COLD PACK DELAY

Some chargers have a Hot/Cold Pack Delay feature: when the charger detects a battery that is hot, it automatically starts a Hot Pack Delay, suspending charging until the battery has cooled. After the battery has cooled, the charger automatically switches to the Pack Charging mode. This feature ensures maximum battery life. The red light flashes long, then short while in the Hot/Cold Pack Delay mode.

LEAVING THE BATTERY PACK IN THE CHARGER

The charger and battery pack can be left connected with the charge indicator showing Pack Charged.

WEAK BATTERY PACKS: Weak batteries will continue to function but should not be expected to perform as much work.

FAULTY BATTERY PACKS: This charger will not charge a faulty battery pack. The charger will indicate faulty battery pack by refusing to light or by displaying problem pack or charger.

NOTE: This could also mean a problem with a charger.

Important Charging Notes

1. Longest life and best performance can be obtained if the battery pack is charged when the air temperature is between 18 and 24 °C (65 and 75 °F). DO NOT charge the battery pack in an air temperature below +4 °C (+40 °F), or above +40 °C (+105 °F). This is important and will prevent serious damage to the battery pack.
2. The charger and battery pack may become warm to touch while charging. This is a normal condition, and does not indicate a problem. To facilitate the cooling of the battery pack after use, avoid placing the charger or battery pack in a warm environment such as in a metal shed, or an uninsulated trailer.

3. If the battery pack does not charge properly:
 - a. Check operation of receptacle by plugging in a lamp or other appliance;
 - b. Check to see if receptacle is connected to a light switch which turns power off when you turn out the lights;
 - c. Move charger and battery pack to a location where the surrounding air temperature is approximately 18–24 °C (65–75 °F);
 - d. If charging problems persist, take the tool, battery pack and charger to your local service center.
4. The battery pack should be recharged when it fails to produce sufficient power on jobs which were easily done previously. **DO NOT CONTINUE** to use under these conditions. Follow the charging procedure. You may also charge a partially used pack whenever you desire with no adverse affect on the battery pack.
5. Foreign materials of a conductive nature such as, but not limited to, grinding dust, metal chips, steel wool, aluminum foil, or any buildup of metallic particles should be kept away from charger cavities. Always unplug the charger from the power supply when there is no battery pack in the cavity. Unplug charger before attempting to clean.
6. Do not freeze or immerse charger in water or any other liquid.

⚠ WARNING: Shock hazard. Don't allow any liquid to get inside charger. Electric shock may result.

⚠ CAUTION: Never attempt to open the battery pack for any reason. If the plastic housing of the battery pack breaks or cracks, return to a service center for recycling.

Storage Recommendations

1. The best storage place is one that is cool and dry away from direct sunlight and excess heat or cold.
2. For long storage, it is recommended to store a fully charged battery pack in a cool dry place out of the charger for optimal results.

NOTE: Battery packs should not be stored completely depleted of charge. The battery pack will need to be recharged before use.

**SAVE ALL WARNINGS AND INSTRUCTIONS
FOR FUTURE REFERENCE**



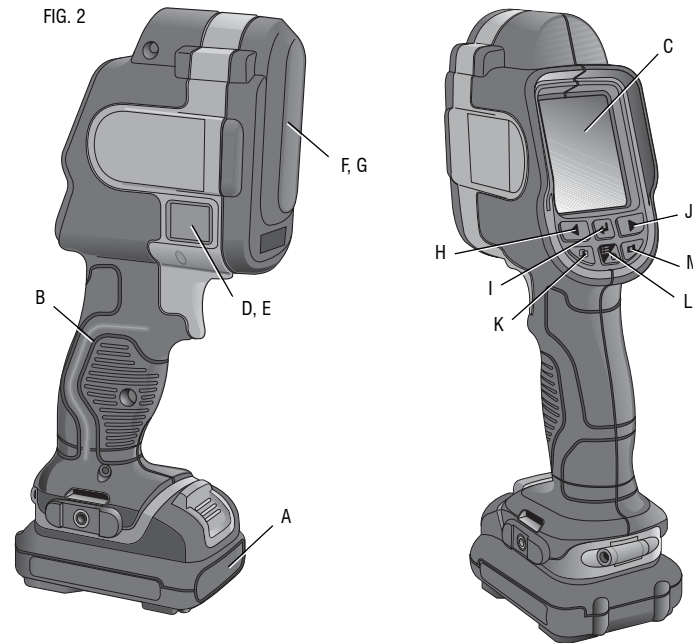



FIG. 2



COMPONENTS (Fig. 2, 3)

⚠ WARNING: Never modify the tool or any part of it. Damage or personal injury could result.

- | | |
|--------------------------------------|-----------------------|
| A. 10.8V XR Lithium-ion battery pack | E. Micro SD card slot |
| B. Handle | F. Lens |
| C. Screen | G. Lens cover |
| D. Micro SD card slot cover | |

- H.  **Back Arrow Button:** Press this button to navigate backward.
- I.  **Select Button:** Press this button to confirm a selection.
- J.  **Forward Arrow Button:** Press this button to navigate forward.
- K.  **Image Blend Adjust Button:** Press this button to change the percentage blend between the visual and thermal images.
- L.  **Menu/Power Button:** Press this button to power the unit on (hold for 0.5 seconds) or off (hold for 3 seconds). When the unit is powered on, press this button to view the menu options.
- M.  **Photo Capture Button:** Press this button for taking a photo.

INTENDED USE

The imaging thermometer measures radiated energy from an object's surface and then uses those measurements to display an image and estimate temperature. Photos can be taken and then saved (bitmap format) on a micro SD card.

The imaging thermometer can be used for inspections and trouble shooting of electrical systems, HVAC, plumbing, mechanical equipment, residential buildings or automotive systems.

The imaging thermometer is a professional tool. **DO NOT** let children come into contact with the tool. Supervision is required when inexperienced operators use this tool.

ASSEMBLY

Belt Hook (Fig. 3) (Optional Accessory)

▲ WARNING: To reduce the risk of serious personal injury, **DO NOT** suspend tool overhead or suspend objects from the belt hook. **ONLY** hang tool's belt hook from a work belt.

▲ WARNING: To reduce the risk of serious personal injury, ensure the screw (N) holding the belt hook is secure.

IMPORTANT: When attaching or removing the belt hook, use only the screw (N) that is provided.

The belt hook (O) can be attached to either side of the tool using only the screw (N) provided, to accommodate left- or right-handed users. If the hook is not desired at all, it can be removed from the tool.

To move belt hook, remove the screw (N) that holds the belt hook in place then reassemble on the opposite side.

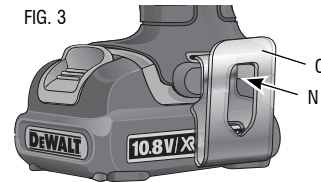

OPERATION

Installing and Removing the Battery Pack (Fig. 4)

NOTE: Make sure your battery pack is fully charged.

To install the battery pack (A) into the tool handle, align the battery with the rails inside the tool's handle and slide it firmly into the handle until you hear the lock snap into place.

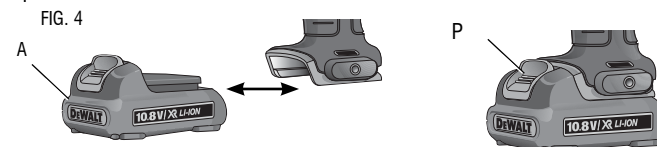

To remove the battery pack from the tool, press the release button (P) and firmly pull the battery pack out of the tool handle. Insert it into the charger as described in the charger section of this manual.

Getting Started (Fig. 2)

1. Slide lens cover (G) down to expose the lens.

POWER ON/OFF

1. To turn on the imaging thermometer, push the menu/power button (L) and hold for 0.5 seconds.
2. To turn off the imaging thermometer, push the menu/power button (L) and hold for 3 seconds.

Initial Setup

DATE AND TIME SETUP

The first time the imaging thermometer is powered on, it will prompt to set the time and date. After the initial setup, the time and date can be changed through the menu navigation.

1. Press the forward (J) or back (H) arrow to highlight the field to change.



2. Press the select button (I) to activate the field. The field will turn green.
3. Press the forward (J) or back (H) arrow to change the activated field.
4. Press the select button (I) to save the changes.
5. Repeat the steps above to change the remaining fields.
6. Press the menu/power button (L) to exit.

Basic Operation

MAIN VIEWING SCREEN

The main screen includes several sections:

- Q. Scanned Area Image
- R. Temperature Measurement at Center of Image (+)
- S. Emissivity Setting
- T. Battery Fuel Gauge
- U. Temperature Color Scale

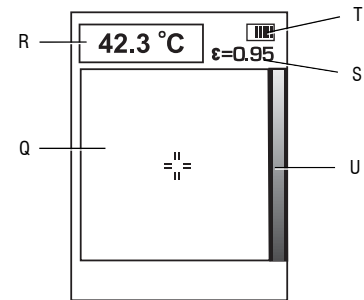

IMAGE BLEND

The DCT416 Imaging Thermometer has the ability to display both a visual image and an infrared image. The images can also be blended on the display to provide an overlay of the thermal image on top of the visual image. A blended image can be helpful in diagnosing trouble spots or communicating with customers.

To change the blend setting, push the image blend adjust button (K). The image blend can be pushed repeatedly to cycle through the following options for display settings:

- 100% Visual
- 75% Visual, 25% Thermal
- 50% Visual, 50% Thermal
- 25% Visual, 75% Thermal
- 100% Thermal

TAKE AND STORE PHOTOS

Make sure a micro SD card is installed in order to save a photo. Open micro SD card slot cover (D) and insert the micro SD card into the slot (E).

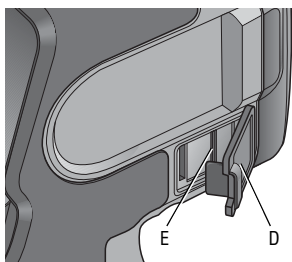

1. Push photo capture button (M).
2. The displayed image will freeze for 3 seconds in order to review the photo.
3. Press the forward (J) or back (H) arrow to highlight save to SD card or delete.

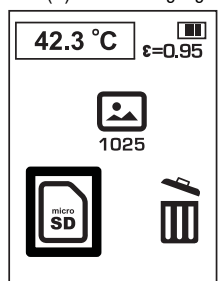

4. Press the select button (I) to confirm selection.
 5. After completion of save or delete, the imaging thermometer will automatically return to the main viewing screen.
- NOTE:** If no SD card is installed or if there is a problem with the SD card, the below communication will appear.

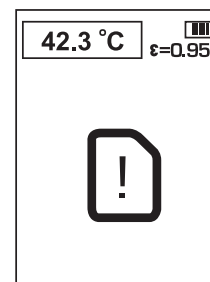

NOTE: If the SD card is full, the below communication will appear.

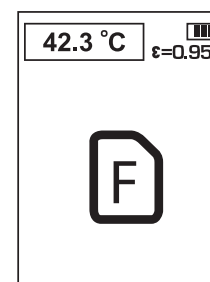

MENU OPTIONS

NOTE: At any time, pushing the menu/power button (L) will return to the previous menu.

TO VIEW PHOTOS

1. Press the menu/power button (L).

2. Press the forward (J) or back (H) arrow to highlight the folder option in the menu.

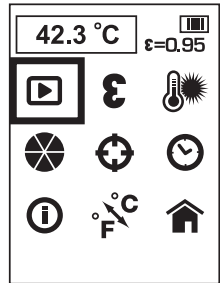

3. Press the select button (I) to confirm selection.
4. Press the forward (J) or back (H) arrow to scroll through saved images.
5. Press the select button (I) to go to the delete sub-menu.
6. Press the forward (J) or back (H) arrow to highlight save to SD card or delete.

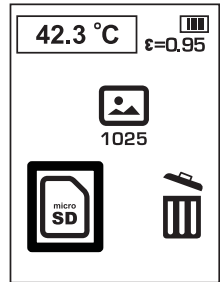

7. Press the select button (I) to confirm selection.
8. After completion of save or delete, the imaging thermometer will automatically return to the next sequential image.

EMISSIVITY

Emissivity describes the energy-emitting characteristics of materials. Most organic materials and painted or oxidized surfaces have an emissivity of about 0.95 which is the default setting. It is recommended to compensate for inaccurate readings that may result from measuring materials with low emissivity values such as shiny metal surfaces. Cover these surfaces with masking tape or flat black paint ($< 148\text{ }^{\circ}\text{C}/300\text{ }^{\circ}\text{F}$) and use the default (0.95) setting. Allow time for the tape or paint to reach the same temperature as the surface beneath it and then measure the temperature of the tape or painted surface.

If you cannot paint or use tape, then you can compensate your measurements with the emissivity selector. Even with the adjustable emissivity, it can be difficult to get a completely accurate infrared measurement of a target with a shiny or metallic surface. Experimentation may be required to benchmark temperatures, and experience will help you choose the best setting for specific measurements.

The imaging thermometer has emissivity adjustable from 0.1 to 1.0 in increments of 0.01. Refer to the Nominal Emissivity Table in this manual. The reference to emissivity settings in the table are suggestions for typical situations and your particular situation may differ.

NOTE: Calibration of this product was performed at 0.95 emissivity.

NOMINAL EMISSIVITY VALUE			
MATERIAL	VALUE	MATERIAL	VALUE
Carbon-filled surface	0.98	Copper, heavily oxidized	0.78
Frost crystals	0.98	Cloth, cotton	0.77
Human skin	0.98	Sand	0.76
Slate	0.97	Silica, unglazed	0.75
Water, distilled	0.96	Iron, oxidized at 100 °C	0.74
Ice, smooth	0.96	Coating No. C20A	0.73
Soil, saturated with water	0.95	Basalt	0.72
Carbon candle soot	0.95	Carbon, graphitized at 500 °C	0.71
Glass, polished plate	0.94	Red Rust	0.70
Paint, oil	0.94	Iron sheet, heavily rusted	0.69
Brick, red	0.93	Water	0.67

Paper, white bond	0.93	Black Loam	0.66
Concrete	0.92	Cement, white	0.65
Soil, dry	0.92	Iron cast, oxidized	0.64
Plaster, rough coat	0.91	Lead, oxidized at 1100 °C	0.63
Wood, planed oak	0.90	Zirconia on inconel	0.62
Earthenware, glazed	0.90	Cu-Zn, brass oxidized	0.61
Snow, granular	0.89	Inconel sheet at 760 °C	0.58
Silica, glazed	0.88	Marble, smooth white	0.56
Cuprous Oxide at 38 °C	0.87	All anodized chromic acid	0.55
Emery Corundum	0.86	Iron cast, polished	0.21
Snow	0.85	Brass, rubbed 80 grit emery	0.20
Stainless, oxidized at 800 °C	0.85	Stainless steel, 18-8 buffed	0.16
Iron, oxidized at 500 °C	0.84	Aluminium as received	0.09
Cuprous Oxide at 260 °C	0.83	Steel, polished	0.07
Snow, fine particles	0.82	Aluminium, polished sheet	0.05
Brass, unoxidized	0.81	Copper, polished	0.05
Glass, convex D	0.80	Brass, highly polished	0.03
Steel, oxidized	0.79		

TO CHANGE EMISSIVITY

1. Press the menu/power button (L).
2. Press the forward (J) or back (H) arrow to highlight the emissivity option in the menu.

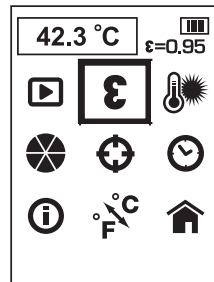

3. Press the select button (I) to confirm selection.
4. Press the forward (J) or back (H) arrow to adjust the emissivity setting. The emissivity can be adjusted in increments of 0.01 from 0.10 to 1.00.
5. Press the the select button (I) to confirm the emissivity setting.
6. After saving the emissivity setting, the imaging thermometer will automatically return to the main menu screen.

BACKGROUND TEMPERATURE

For more accurate temperature measurements, it is recommended to set the background (or reflected) temperature. This is especially important when the object being measured is at a significantly different temperature than ambient or if the object being measured has a low emissivity.

Setting the background temperature will help compensate for the radiation from the surroundings.

TO CHANGE BACKGROUND TEMPERATURE

1. Press the menu/power button (L).
2. Press the forward (J) or back (H) arrow to highlight the background temperature option in the menu.

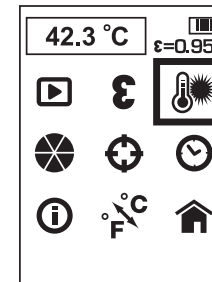

3. Press the select button (I) to confirm selection.
4. Press the forward (J) or back (H) arrow to adjust the background temperature. The background temperature can be adjusted in 1 degree increments.

5. Press the select button (I) to confirm the background temperature setting.
6. After saving the background temperature setting, the imaging thermometer will automatically return to the main menu screen.

TO CHANGE COLOR PALETTE

1. Press the menu/power button (L).
2. Press the forward (J) or back (H) arrow to highlight the color palette option in the menu.

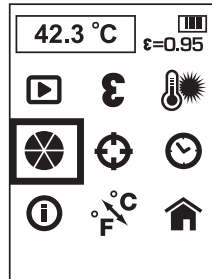

3. Press the select button (I) to confirm selection.
4. Press the forward (J) or back (H) arrow to scroll through the color palette options. The five palette choices include: Ironbow, White Hot, Black Hot, Rainbow, and High Contrast.
5. Press the select button (I) to confirm the color palette setting.
6. After saving the color palette setting, the imaging thermometer will automatically return to the main menu screen.

TO CHANGE THE TRACKING SETTING

When the tracking feature is on, the imaging thermometer will locate the hottest (red o) and coldest (blue o) spot in the displayed area. The imaging thermometer can moved to align the center measurement spot (+) to the desired location.

NOTE: The displayed temperature always corresponds to the center (+).

1. Press the menu/power button (L).
2. Press the forward (J) or back (H) arrow to highlight the tracking option in the menu.

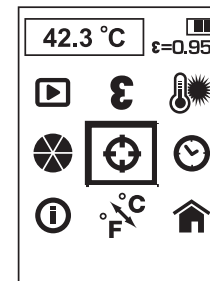

3. Press the select button (I) to confirm selection.
4. Press the forward (J) or back (K) arrow to turn on or off the tracking feature.
5. Press the select button (I) to confirm the tracking feature setting.
6. After saving the tracking feature setting, the imaging thermometer will automatically return to the main menu screen.

TO SET DATE AND TIME

1. Press the menu/power button (L).
2. Press the forward (J) or back (H) arrow to highlight the date and time option in the menu.

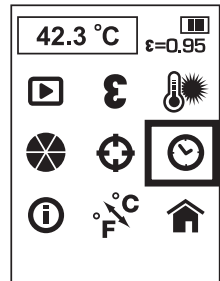

3. Press the select button (I) to confirm selection.
4. Press the forward (J) or back (H) arrow to highlight the field to change.



5. Press the select button (I) to activate the field. The field will turn green.
6. Press the forward (J) or back (H) arrow to change the activated field.
7. Press the select button (I) to save the changes.
8. Repeat the steps above to change the remaining fields.
9. Press the menu/power button (L) to exit.

TO VIEW INFORMATION

1. Press the menu/power button (L).
2. Press the forward (J) or back (H) arrow to highlight the information option in the menu.

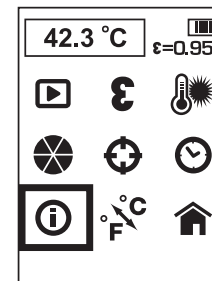

3. Press the select button (I) to confirm selection.
4. The imaging thermometer will display the software version.
5. Press the menu/power button (L) to exit.

TO CHANGE TEMPERATURE SCALES

1. Press the menu/power button (L).
2. Press the forward (J) or back (H) arrow to highlight the C / F option in the menu.

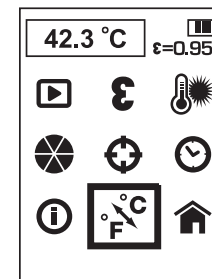

3. Press the select button (I) to confirm selection
4. Press the forward (J) or back (H) arrow to highlight either C or F.
5. Press the select button (I) to confirm selection.
6. After saving the temperature scale setting, the imaging thermometer will automatically return to the main menu screen.

RETURN TO THE MAIN VIEWING SCREEN

1. Press the menu/power button (L).
2. Press the forward (J) or back (H) arrow to highlight the home option in the menu.

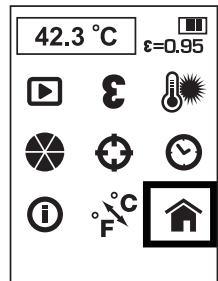

3. Press the select button (I) to confirm selection.

TO DOWNLOAD IMAGES TO COMPUTER

The imaging thermometer records both the thermal and visual image for each saved photo. Images are saved in bitmap format.

The micro SD card can be transferred to a computer to view the images.

REPORT WRITING SOFTWARE

The imaging thermometer utilises report writing software to produce professional reports. The software can be downloaded from www.2helpU.com.

TO TURN OFF IMAGING THERMOMETER

1. To turn off the imaging thermometer, push the menu/power button (L) and hold for 3 seconds. The imaging thermometer will also automatically turn off after 10 minutes of non-use.
2. Slide lens cover (G) up to protect lens when not in use.

Operating Tips

- Use only DeWALT 10.8V lithium-ion battery.
- Ensure the DeWALT battery is in good working condition. If the battery fuel gauge on the screen is empty, the battery needs to be recharged.
- Avoid sudden changes in temperature such as when entering or leaving a heated building on a cold day as this can cause condensation inside the imaging thermometer. To prevent condensation, place the imaging thermometer in the kitbox or a plastic bag before exposing it to sudden changes in temperature.

MAINTENANCE

Cleaning

⚠WARNING: Blow dirt and dust out of all air vents with clean, dry air at least once a week. To minimize the risk of eye injury, always wear AS/NZS51337 approved eye protection when performing this.

⚠WARNING: Do not apply solvents to the lens as this may cause damage. Do not clean the infrared lens too vigorously as this can damage the delicate anti-reflective coating.

⚠WARNING: Never use solvents or other harsh chemicals for cleaning the non-metallic parts of the tool. These chemicals may weaken the plastic materials used in these parts. Use a cloth dampened only with water and mild soap. Never let any liquid get inside the tool; never immerse any part of the tool into a liquid.

CHARGER CLEANING INSTRUCTIONS

⚠WARNING: Shock hazard. Disconnect the charger from the AC outlet before cleaning. Dirt and grease may be removed from the exterior of the charger using a cloth or soft non-metallic brush. Do not use water or any cleaning solutions.

Troubleshooting

- Make sure the lens cover (G) is open.
- Make sure the DeWALT 10.8V lithium-ion battery is charged.
- Make sure the battery is installed on the handle set when in use.
- If the screen freezes, remove the DeWALT 10.8V battery pack to reset the unit. Reinsert the battery pack and press the power on button.

KEY NOTES IF HAVING TROUBLE TAKING MEASUREMENT

1. Make sure to apply masking tape or flat black paint to surfaces that are highly reflective (use the default 0.95 emissivity setting).
2. Make sure to have the correct emissivity for the material you are testing. Refer to Emissivity and Nominal Emissivity Table.
3. Clean the material before testing if there is heavy dirt, grease, etc.

Repairs

The charger and battery pack are not serviceable. There are no serviceable parts inside the charger or battery.

To assure product SAFETY and RELIABILITY, repairs, maintenance and adjustment (including brush inspection and replacement) should be performed by certified service centers or other qualified service organizations, always using identical replacement parts.

ACCESSORIES

▲ WARNING: Since accessories, other than those offered by DEWALT, have not been tested with this product, use of such accessories with this tool could be hazardous. To reduce the risk of injury, only DEWALT, recommended accessories should be used with this product.

Recommended accessories for use with your tool are available at extra cost from your local service center. If you need any assistance in locating any accessory, please contact Stanley Black & Decker, 82 Taryn Drive, Epping, VIC 3076 Australia or call 1800 444 224 or (NZ). 0800 339 258.





DeWALT BATTERY AND CHARGER SYSTEMS																									
Battery		Chargers/Charge Time																							
Cat. Number	Voltage	Output Nominal Amp Hour	230 Volts																	12 Volts					
			97014	98014	DW9106	DW9107	DW9108	DW9115	DW9116	DW9117	DW9118	DE9116	DE9118	DW911	DC011	DW0245	DE2046	DC9000	DC9310	DCB100	DCB103	DCB105	DCB119	DW9109	DC9319
DC9360	36	2.2	X	X	X	X	X	X	X	X	X	X	X	X	X	X	X	X	X	X	X	X	X	X	X
DE0240-XJ	24	2.0	X	X	X	X	X	X	X	X	X	X	X	X	60	60	X	X	X	X	X	X	X	X	X
DW0242	24	2.0	X	X	X	X	X	X	X	X	X	X	X	X	60	60	X	X	X	X	X	X	X	X	X
DW0240	24	1.7	X	X	X	X	X	X	X	X	X	X	X	X	60	60	X	X	X	X	X	X	X	X	X
DC9096	18	2.4	X	X	X	X	60	X	60	20	X	60	X	60	60	X	X	X	60	X	60	X	X	60	60
DC9180	18	2.0	X	X	X	X	X	X	X	X	X	X	X	X	X	X	X	60	X	60	X	X	X	60	60
DCB180	18	3.0	X	X	X	X	X	X	X	X	X	X	X	X	X	X	X	X	X	X	60	60	90	X	X
DCB181	18	1.5	X	X	X	X	X	X	X	X	X	X	X	X	X	X	X	X	X	30	30	40	X	X	
DCB182	18	4.0	X	X	X	X	X	X	X	X	X	X	X	X	X	X	X	X	X	90	90	117	X	X	
DW9096	18	2.4	X	X	X	X	60	X	60	20	X	60	X	60	60	X	X	X	60	X	60	X	X	60	60
DE9095-XJ	18	2.0	X	X	X	X	60	X	60	20	X	60	X	60	60	X	X	X	60	X	60	X	X	60	60
DC9091	14.4	2.4	60	60	60	60	60	15	60	15	60	60	60	60	60	X	X	X	60	X	60	X	X	60	60
DC9144	14.4	2.0	X	X	X	X	X	X	X	X	X	X	X	X	X	X	X	X	60	X	60	X	X	X	60
DCB141	14.4	1.5	X	X	X	X	X	X	X	X	X	X	X	X	X	X	X	X	X	30	30	40	X	X	
DCB142	14.4	4.0	X	X	X	X	X	X	X	X	X	X	X	X	X	X	X	X	X	90	90	117	X	X	
DE9094	14.4	1.3	45	45	45	30	30	15	30	12	60	30	60	30	30	X	X	X	30	X	30	X	X	30	30
DE9091-XJ	14.4	2.0	45	45	45	45	45	15	45	15	90	45	90	45	45	X	X	X	45	X	45	X	X	45	45
DW9091	14.4	1.7	45	45	45	45	45	15	45	15	90	45	90	45	45	X	X	X	45	X	45	X	X	45	45
DC9071	12	2.4	60	60	60	60	60	15	60	15	60	60	60	60	60	X	X	X	60	X	60	X	X	60	60
DE9071-XJ	12	2.0	60	60	60	45	45	15	45	15	90	45	90	45	45	X	X	X	45	X	45	X	X	45	45
DE9074-XJ	12	1.25	45	45	45	30	30	15	30	12	60	30	60	30	30	X	X	X	30	X	30	X	X	30	30
DW9050	12	1.3	40	40	40	X	X	15	X	X	X	X	X	X	X	X	X	X	X	X	X	X	X	X	X
DW9071	12	1.7	60	60	60	45	45	15	45	15	90	45	90	45	45	X	X	X	45	X	45	X	X	45	45
DW9072	12	1.2	45	45	45	30	30	15	30	12	60	30	60	30	30	X	X	X	30	X	30	X	X	30	30
DCB120	10.8	1.3	X	X	X	X	X	X	X	X	X	X	X	X	X	X	X	X	X	40	40	40	40	X	X
DCB123	10.8	1.5	X	X	X	X	X	X	X	X	X	X	X	X	X	X	X	X	X	40	40	40	40	X	X
DW9063	9.6	1.25	45	45	45	30	30	15	30	12	60	30	60	30	30	X	X	X	30	X	30	X	X	30	30
DW9062	9.6	1.3	45	45	45	30	30	15	30	12	60	30	60	30	30	X	X	X	30	X	30	X	X	30	30
DW9061	9.6	1.7	60	60	60	45	45	15	45	15	90	45	90	45	45	X	X	X	45	X	45	X	X	45	45
DW9048	9.6	1.3	40	40	40	X	X	15	X	X	X	X	X	X	X	X	X	X	X	X	X	X	X	X	X
DW9057	7.2	1.25	45	45	45	30	30	15	30	12	60	30	60	30	30	X	X	X	30	X	30	X	X	30	30
DW9046	7.2	1.3	40	40	40	X	X	15	X	X	X	X	X	X	X	X	X	X	X	X	X	X	X	X	X

X Indicates that the battery pack is not compatible with that specific charger.
All charge times are approximate. Actual charge time may vary.
Read the instruction manual for more specific information.
The battery voltage is nominal, it can measure above or below depending on the state of charge.

Stanley Black & Decker
82 Taryn Drive, Epping, VIC 3076 Australia • 1800 444 224 (Aust) or 0800 339 258 (NZ)
www.dewalt.com.au • www.dewalt.co.nz
(AUG12) Part No. N178741 DCT416-XE Copyright © 2012 DeWALT

The following are trademarks for one or more DeWALT power tools: the yellow and black color scheme; the "D" shaped air intake grill; the array of pyramids on the handgrip; the kit box configuration; and the array of lozenge-shaped humps on the surface of the tool.